

INSTALLING T400 LOAD SENSORS

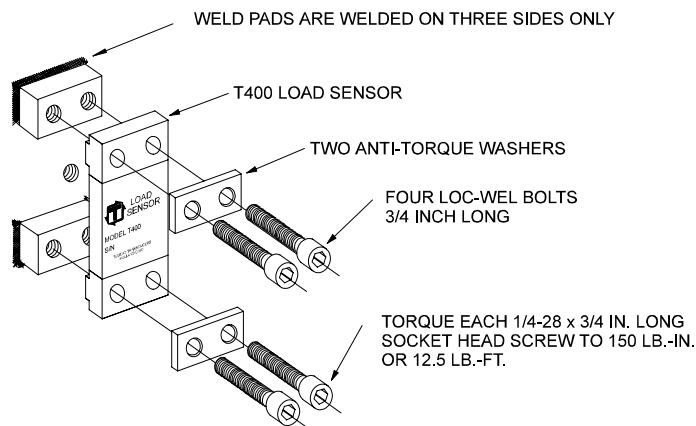
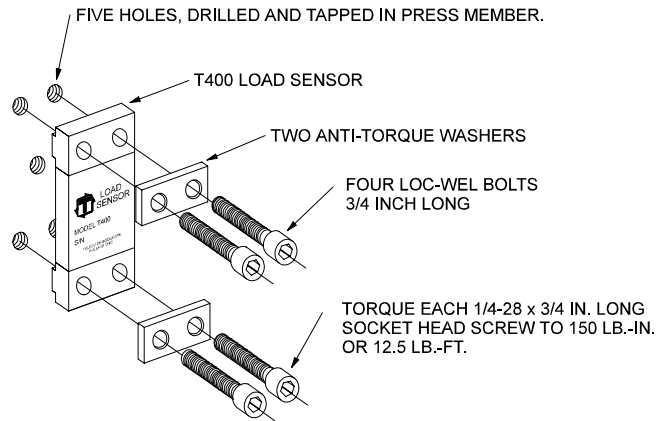

The above illustrations represent the proper arrangement of Model T400 Load Sensor kit parts using either the Drill and Tap method or the Weld method.

A proper installation is necessary to produce good results.

Before installing the sensors, please read the appropriate instructions listed below.

Sensor Placement	Page 2
Press Frame	Page 3
Pitman Mount	Page 4
Drill and Tap Method of Installing Sensors	Page 5
Weld Method of Installing Sensors	Page 6
T400 Enclosure Mounting Details	Page 7

NOTES:

- 1) (2) SENSORS REQUIRED
- 2) (2) SENSOR ENCLOSURES ARE INCLUDED. THESE HELP PROTECT THE T400 SENSOR GAUGES. THESE ENCLOSURES INCLUDE 1/2" KNOCK-OUT HOLES. IF CONDUIT IS USED, WE SUGGEST USING 1/2" STRAIN RELIEFS IN THE KNOCK-OUT HOLES.

SENSOR PLACEMENT

Sensor location must be determined. You have two locations. The front or the rear of the press. (Shown in the shaded area.)

HOW TO DETERMINE THE BEST LOCATION

* MEASURE THE REAR THICKNESS _____ REAR

* MULTIPLY BY THREE X 3 =

* MEASURE THE FRONT THICKNESS _____ FRONT

If the front thickness is smaller than value in , then mount sensors in the front. (This is the most common.)
If the front thickness is larger, then place the sensor in the rear. Adjust the input connection for compression readings instead of tension.

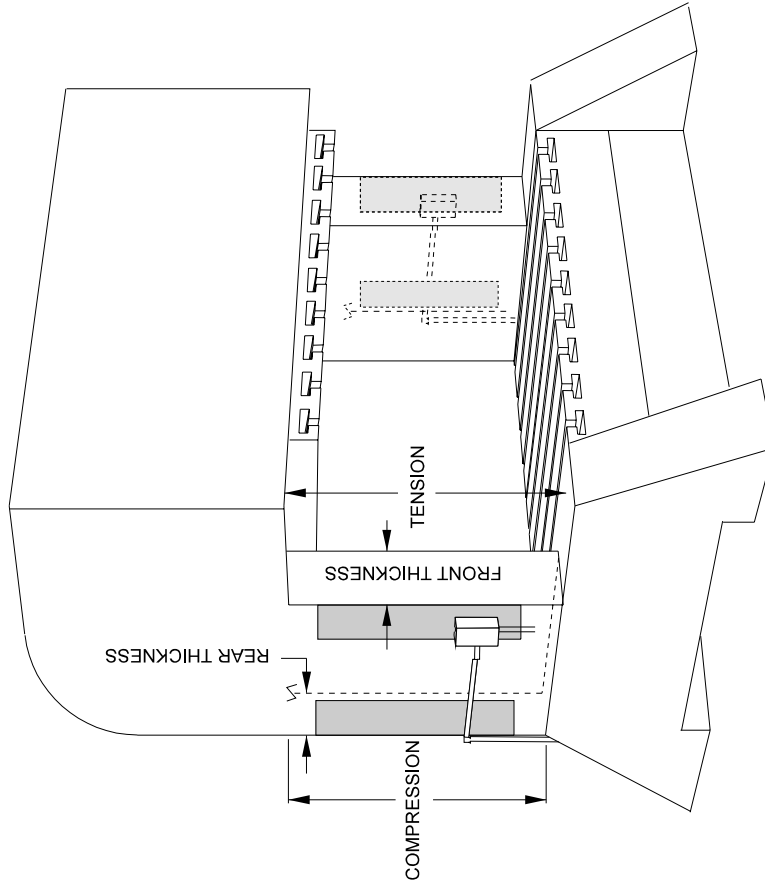

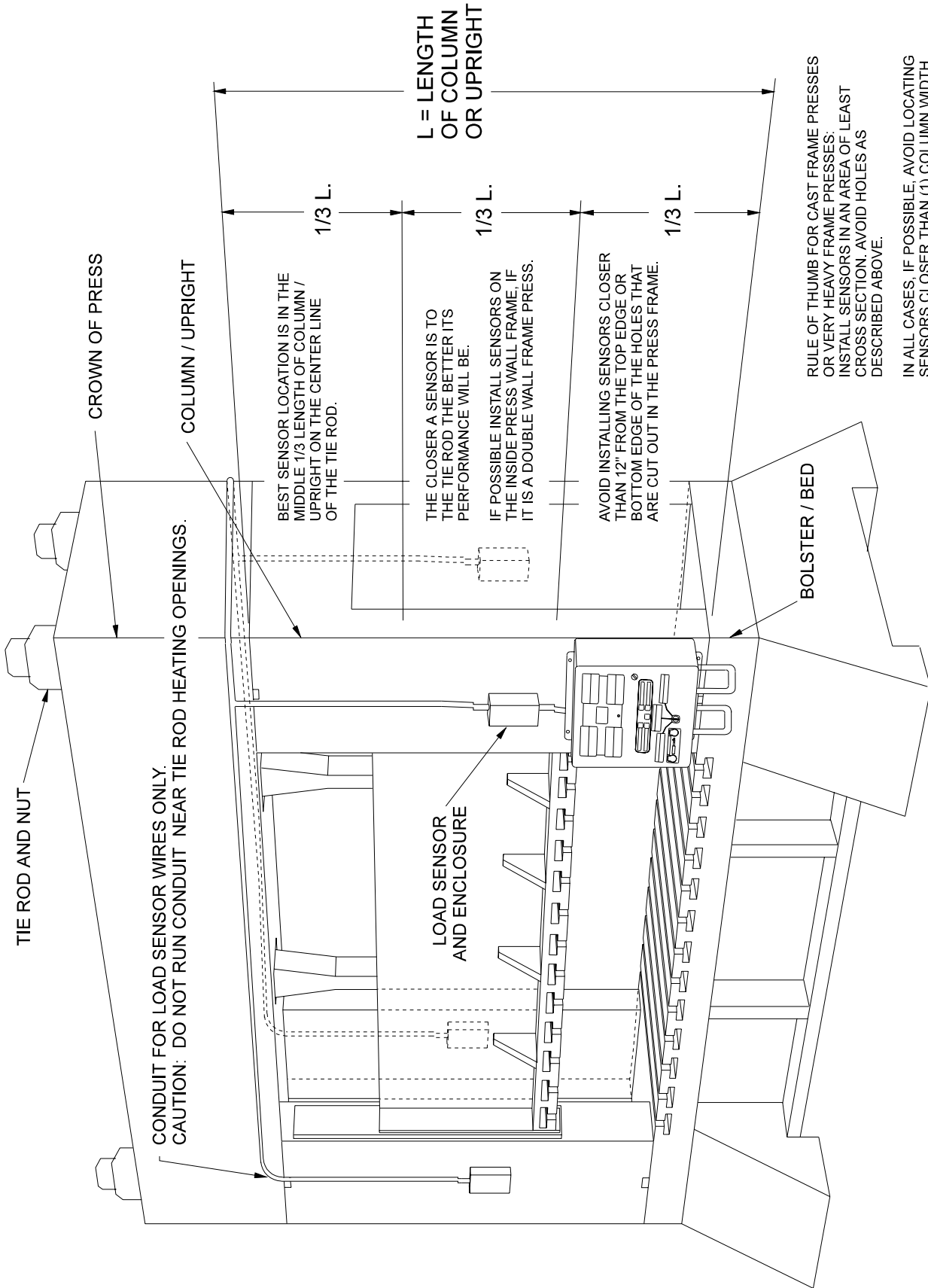

L = LENGTH OF COLUMN OR UPRIGHT

1/3 L.

1/3 L.

1/3 L.

CROWN OF PRESS

COLUMN / UPRIGHT

BEST SENSOR LOCATION IS IN THE MIDDLE 1/3 LENGTH OF COLUMN / UPRIGHT ON THE CENTER LINE OF THE TIE ROD.

THE CLOSER A SENSOR IS TO THE TIE ROD THE BETTER ITS PERFORMANCE WILL BE.

IF POSSIBLE INSTALL SENSORS ON THE INSIDE PRESS WALL FRAME, IF IT IS A DOUBLE WALL FRAME PRESS.

AVOID INSTALLING SENSORS CLOSER THAN 12" FROM THE TOP EDGE OR BOTTOM EDGE OF THE HOLES THAT ARE CUT OUT IN THE PRESS FRAME.

RULE OF THUMB FOR CAST FRAME PRESSES OR VERY HEAVY FRAME PRESSES: INSTALL SENSORS IN AN AREA OF LEAST CROSS SECTION. AVOID HOLES AS DESCRIBED ABOVE.

IN ALL CASES, IF POSSIBLE, AVOID LOCATING SENSORS CLOSER THAN (1) COLUMN WIDTH FROM THE CROWN OR BOLSTER.

CONDUIT FOR LOAD SENSOR WIRES ONLY.
CAUTION: DO NOT RUN CONDUIT NEAR TIE ROD HEATING OPENINGS.

LOAD SENSOR AND ENCLOSURE

BOLSTER / BED

TIE ROD AND NUT

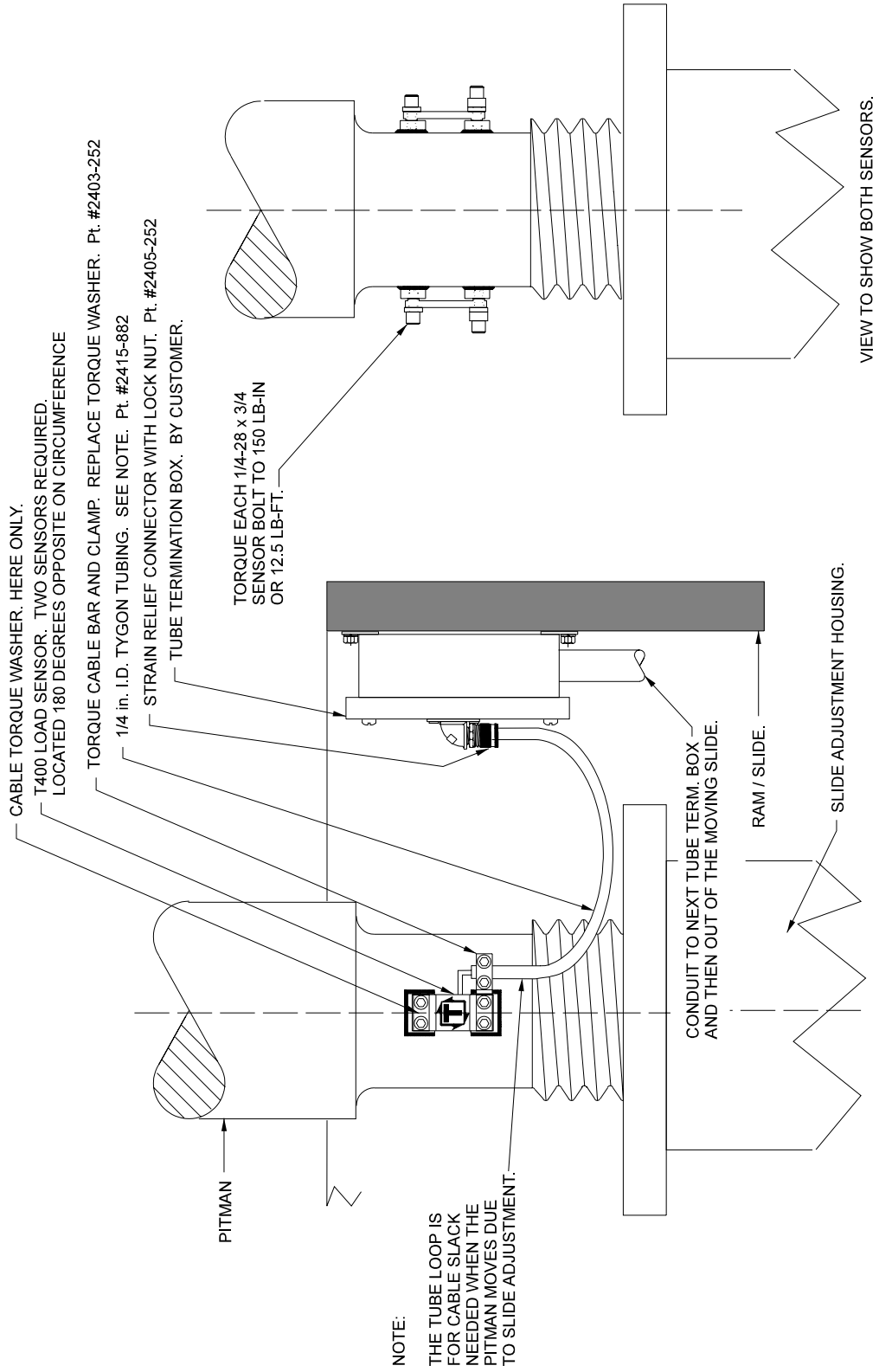

USING THE T400 SENSOR INSTALLATION FIXTURE KIT No. 1977-749

(METRIC INSTALLATION FIXTURE KIT No. 1974-749)

DRILL AND TAP METHOD FOR MOUNTING SENSORS

BE SURE THE SENSOR LOCATION FOLLOWS THE BEST LOCATION DESCRIBED ON THE PREVIOUS PAGES.

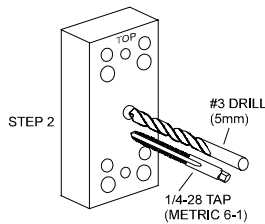

STEP 1 Remove all paint and grease from sensor mount area. If the machine surface is flat (total indicated reading of .002”) and smooth (125 μ in.) the load sensor can be bolted directly to the surface.

STEP 2 Drill and tap the center hole for mounting the fixture to the press member. This hole should be ½ inch (13mm) deep.

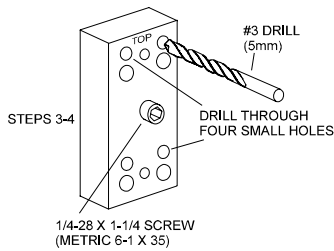

STEP 3 Bolt the fixture to the press member using the ¼-28 by 1-¼ inch (M6-1 x 35) long socket head cap screw in the center of the fixture.

STEP 4 Insert the number 3 drill (5mm) into the smaller corner hole and drill out all four holes to a depth of ¾ of an inch (19mm.)

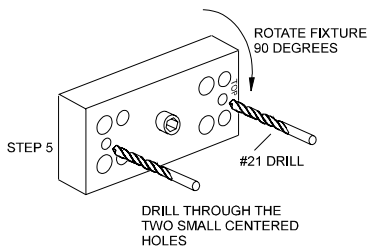

STEP 5 Loosen the fixture. Rotate the fixture 90 degrees clockwise. Tighten the center screw of the fixture. Insert the number 21 drill into the small centered hole and drill out both holes to a depth of 3/8 of an inch. These holes are for mounting the sensor enclosure. The fixture does not allow for tapping these holes. They are tapped without the fixture. Enclosure mounting is not done in metric.

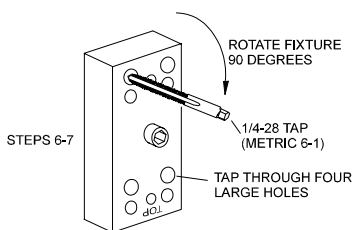

STEP 6 Loosen the fixture. Rotate the fixture another 90 degrees clockwise such that the larger corner holes line up with the holes drilled in Step 4. Insert a tap to be sure the holes line up. Lock the fixture in place by tightening the center screw.

STEP 7 Insert the tap into the larger tap guide holes and tap each hole.

BE SURE TO USE PLENTY OF TAPPING FLUID.

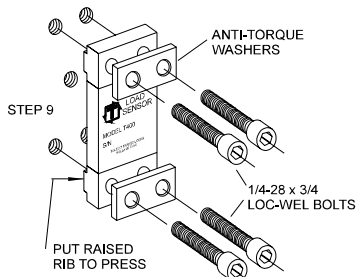

STEP 8 Remove the fixture and repeat Steps 1-7 for each additional sensor mounting position.

STEP 9 Mount the sensor with the raised rib to the press. The anti-torque washers should go between the screw and the sensor body. Torque each ¼-28 x ¾ in. long socket head cap screw to 150 LB.-IN or 12.5 LB.-FT.

USING THE T400 SENSOR INSTALLATION FIXTURE KIT No. 1977-749

WELD PAD METHOD FOR MOUNTING SENSORS

BE SURE THE SENSOR LOCATION FOLLOWS THE BEST LOCATION DESCRIBED ON THE PREVIOUS PAGES.

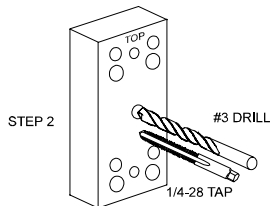

STEP 1 Remove all paint, grease, and or rust from surface to be welded. (Surface should be flat T.I.R. 1/32 of an inch.)

STEP 2 Drill and tap the center hole for mounting the fixture to the press member. This hole should be 1/2 inch deep. (Optional)

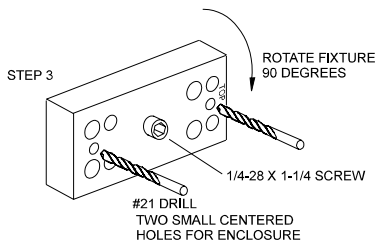

STEP 3 Bolt the fixture to the press member using the 1/4-28 by 1-1/4 inch long socket head cap screw in the center of the fixture. Orient the fixture as shown and drill out the #21 holes to a depth of 3/8 of an inch for the enclosure mounting. The fixture is not used for tapping these holes. (Optional)

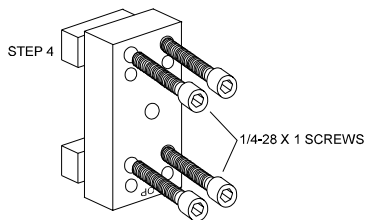

STEP 4 Remove the fixture from the press member. Bolt the weld pads to the fixture with 1/4-28 by 1 inch long socket head cap screws provided. Reattach the fixture with the weld pads bolted on using the center hole as in Step 3. Orient the fixture as shown.

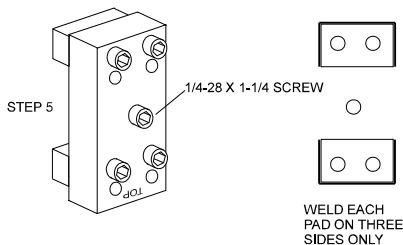

STEP 5 Weld the weld pads to the press member. (BE SURE TO ONLY WELD THE WELD PADS ON THREE SIDES AS SHOWN.) A single pass is sufficient. Do not remove the fixture until slag is removed and or assembly has cooled. When welding cast iron, use a dry nickel rod such as: Lincoln Electric "Soft Weld", Hobart "NI Cast 99", or MB Weld Prod. "MG 210. Strike arc on steel then puddle into the cast iron.

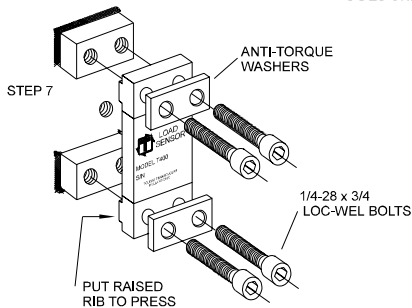

STEP 6 Remove the weld fixture. DO NOT WELD AFTER FIXTURE IS REMOVED. The 4 screws holding the pads to the fixture and the 1 center screw may be discarded. DO NOT USE THE FOUR 1 INCH LONG SCREWS TO ASSEMBLE SENSOR. The sensor kit contains four 3/4 inch long screws for assembling the sensor to the press member. Weld pad surface must be clean – no weld bumps, scratches, etc. Be sure the weld pad tapped holes are clean and bottom of holes are free of weld flash.

STEP 7 Mount the sensor with the raised rib to the press. The anti-torque washers should go between the screw and the sensor body. Torque each 1/4-28 x 3/4 in. long socket head screw to 150 LB.-IN or 12.5 LB.-FT.

SENSOR ENCLOSURE MOUNTING

USE 10-32 TAP IN THE TWO 3/8" DEEP HOLES THAT WERE DRILLED WITH THE FIXTURE IN THE PREVIOUS INSTRUCTIONS. MOUNT THE ENCLOSURE TO THE PRESS MEMBER AND RUN 1/2 INCH CONDUIT TO THE LOAD MONITOR ENCLOSURE.

RUN SENSOR CABLE THROUGH CONDUIT. PLACE SENSOR ON MOUNTING HOLES. PLACE ANTI-TORQUE WASHERS OVER SENSOR HOLES. SCREW IN SENSORS BOLTS, (4) EACH, FINGER TIGHT. USE ONLY THE 1/4-28 x 3/4 "LOC-WEL" BOLTS THAT ARE IN THE SENSOR PACKAGE. TORQUE EACH 1/4-28 x 3/4 SCREW TO 150 LB.-IN. OR 12.5LB.-FT. ASSEMBLE BOX COVER.

